

STAINLESS STEEL PERFORATED GRILLES - SSPG

304 (Standard) or 316 (Optional) Stainless - Satin Finish

20 GA. Frame, 20 GA. Perforated Face
 Maximum single section 60" x 48". Sizes larger than 60" x 48" available.
 Available options include: opposed blade damper or plaster frame.
 See reverse side for butting details on multiple piece grilles.

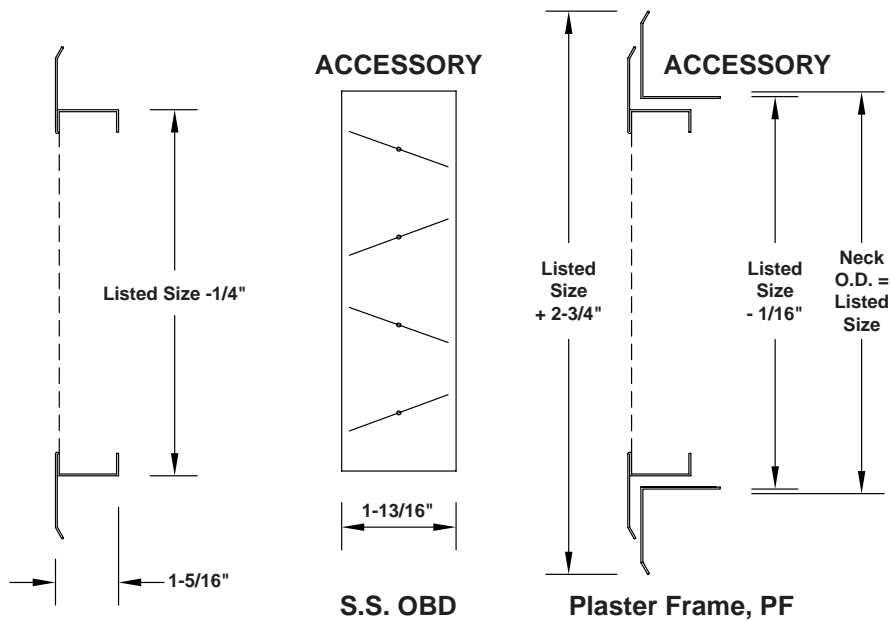
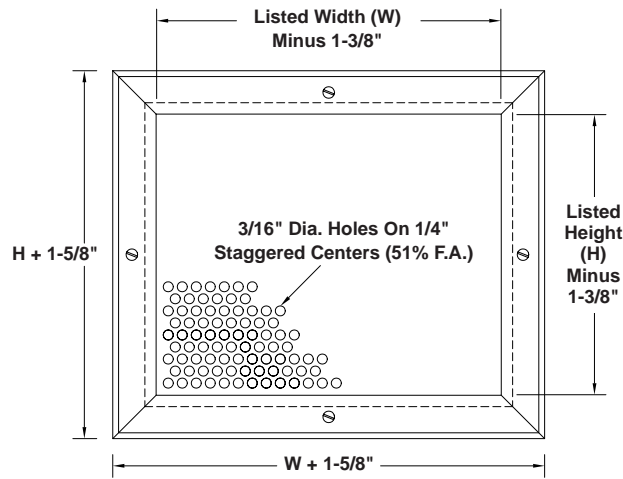

Qty.	Model	W	H	Type S.S.		Plaster Frame	Tag
				Grille	O.B.D.		

To maintain KEES' policy of continuous product improvement, we reserve the right to change prices, specifications, ratings or dimensions without notice or obligation.

Project				Location			
Engineer				Dwg. No.	SD-SSPG	 KEES INCORPORATED 400 S. Industrial Dr. • P.O. Box L Elkhart Lake, WI 53020 Phone: (920) 876-3391 Fax: (920) 876-3065 Website: www.kees.com	
Architect			Date				08/09
Contractor							

STAINLESS STEEL PERFORATED GRILLES - SSPG

304 or 316 Stainless - Satin Finish

20 GA. Frame, 20 GA. Blades

Maximum single piece size for double deflection grille is 48" x 48".

Maximum single piece size for single deflection grille is 60" x 48" or 48" x 60".

Larger order sizes will be made in multiple individual sections to fit opening size.

Mullion supports within opening to be provided by others.

BUTTING DETAIL

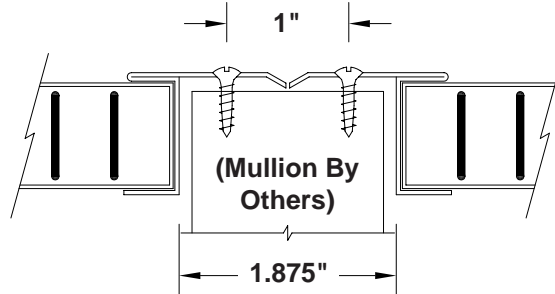

SINGLE DEFLECTION

60" < Listed Size ≤ 120"

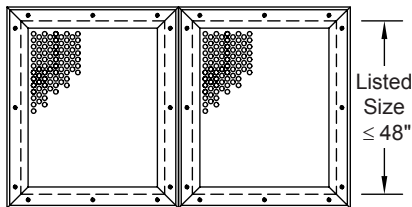

SINGLE DEFLECTION

48" < Listed Size ≤ 96"

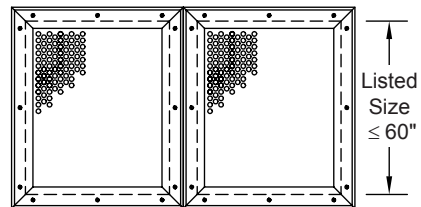

OR

60" < Listed Size ≤ 120"

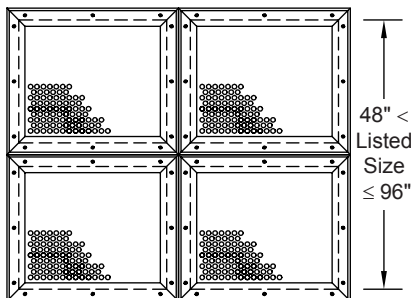

48" < Listed Size ≤ 96"

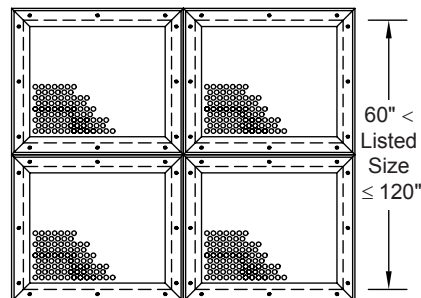

OR

To maintain KEES' policy of continuous product improvement, we reserve the right to change prices, specifications, ratings or dimensions without notice or obligation.

Project		Location	
Engineer			
Architect	Dwg. No.	SD-SSPG	 KEES INCORPORATED 400 S. Industrial Dr. • P.O. Box L Elkhart Lake, WI 53020 Phone: (920) 876-3391 Fax: (920) 876-3065 Website: www.kees.com
Contractor	Date	08/09	



MODEL SSRG Stainless Steel Perforated Face Return Grilles

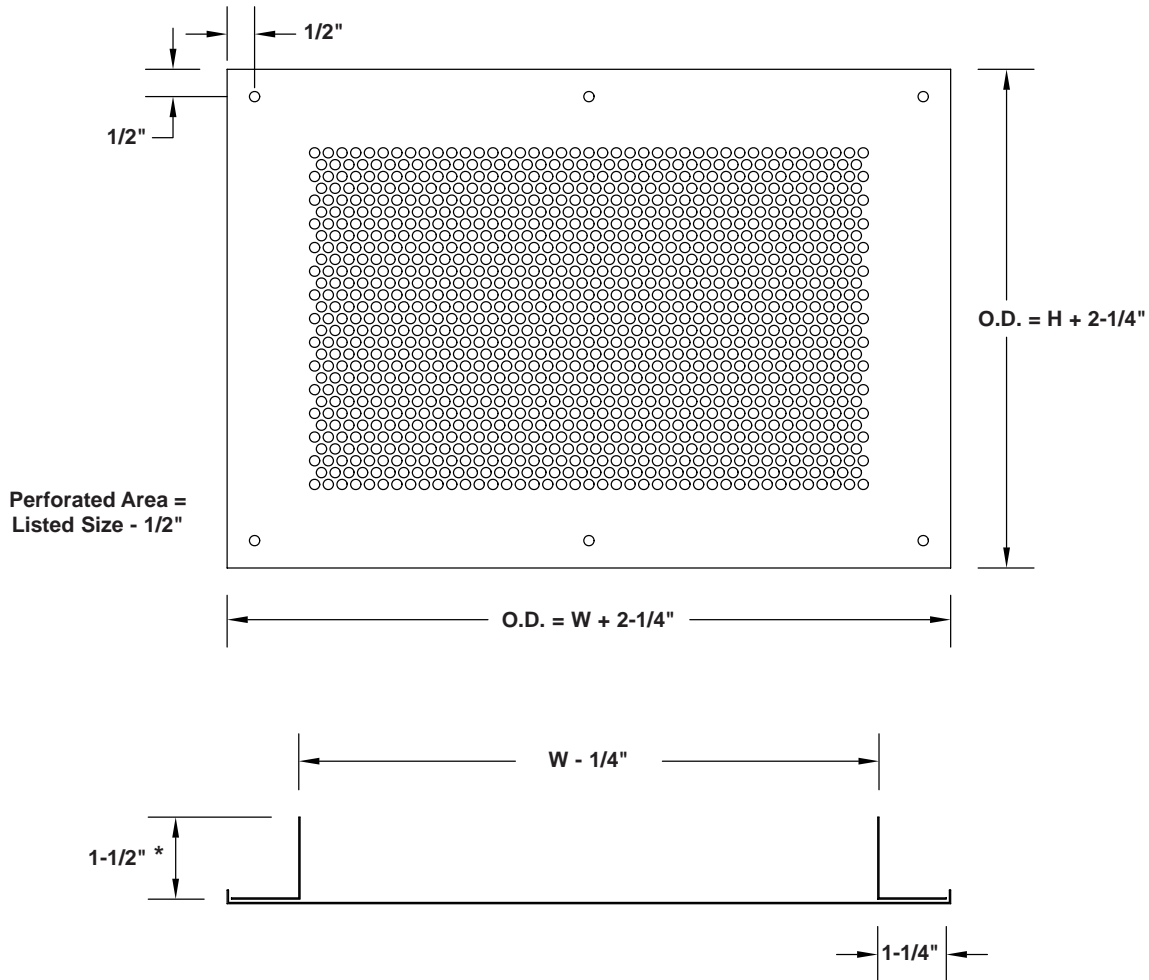

MATERIAL: 20 GA. Stainless Steel With Satin Polished Finish. Type 304 (Standard) or 316 (Optional).

3/16" Dia. Holes On 1/4" Staggered Centers.

Screw Holes For #8 Pan Head Phillips Screws.

Optional Damper Of Steel, 304 S.S. (Standard) or 316 S.S. (Optional).

* 3" With Optional O.B.D.

Qty.	W	H	Grille		O.B.D.		Finish	Tag
			304 S.S.	316 S.S.	304 S.S.	316 S.S.		

To maintain KEES' policy of continuous product improvement, we reserve the right to change prices, specifications, ratings or dimensions without notice or obligation.

Project				Location				
Engineer					KEES INCORPORATED 400 S. Industrial Dr. • P.O. Box L Elkhart Lake, WI 53020 Phone: (920) 876-3391 Fax: (920) 876-3065 Website: www.kees.com			
Architect			Dwg. No.	SD-SSRG				
Contractor			Date	08/06				