

STAINLESS STEEL FILTER GRILLES

304 (Standard) or 316 (Optional) Stainless - Satin Finish

20 GA. Frame, 24 GA. Blades
 Maximum single section 60" x 48". Sizes larger than 60" x 48" available.
 Available options include: opposed blade damper, no filter clips, no hinge (removable grille).
 See reverse side for butting details on multiple piece grilles.

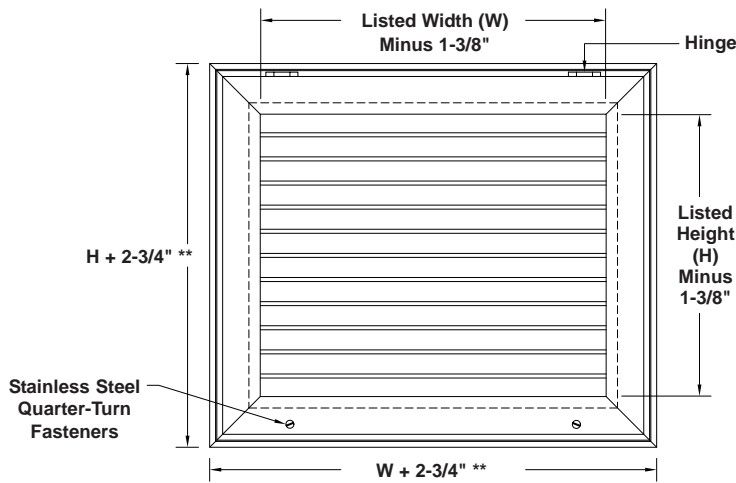

BLADE DETAIL



‡ 2-3/16" For 1" Filter,
 3-1/2" For 2" Filter.

** For Lay-In Applications,
 Frame O.D. is Listed Size +2.75".
 Listed Size is Lay-In Module Size -3".

*Filter by Others.

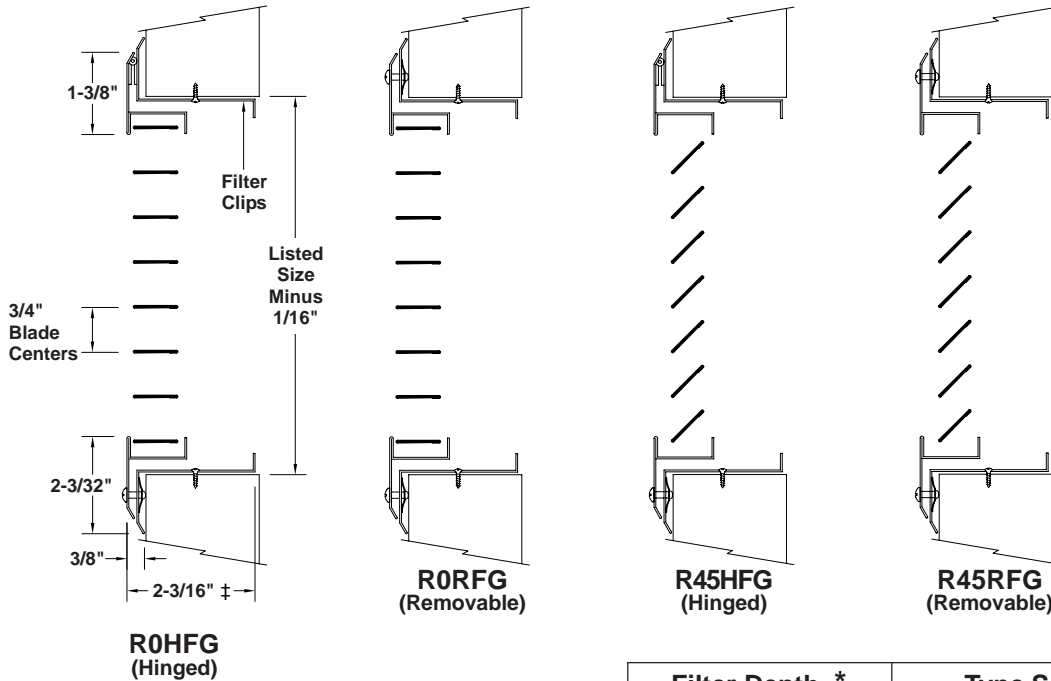

ACCESSORY

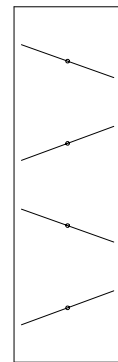

1-13/16"
S.S. OBD
 (Attached to rear of filter frame)

Qty.	Model	W	H	Filter Depth *		Type S.S.		O.B.D.	Tag
				1"	2"	304	316		

To maintain KEES' policy of continuous product improvement, we reserve the right to change prices, specifications, ratings or dimensions without notice or obligation.

Project				Location					
Engineer					 KEES INCORPORATED 400 S. Industrial Dr. • P.O. Box L Elkhart Lake, WI 53020 Phone: (920) 876-3391 Fax: (920) 876-3065 Website: www.kees.com				
Architect			Dwg. No.	SD-SSFG					
Contractor			Date	05/07					

STAINLESS STEEL FILTER GRILLES

304 (Standard) or 316 (Optional) Stainless - Satin Finish

20 GA. Frame, 24 GA. Blades

Maximum single section 60" x 48". Sizes larger than 60" x 48" available.

Available options include: opposed blade damper, no filter clips, no hinge (removable grille).

Larger order sizes will be made in multiple individual sections to fit opening size.

Mullion supports within opening to be provided by others.

BUTTING DETAIL

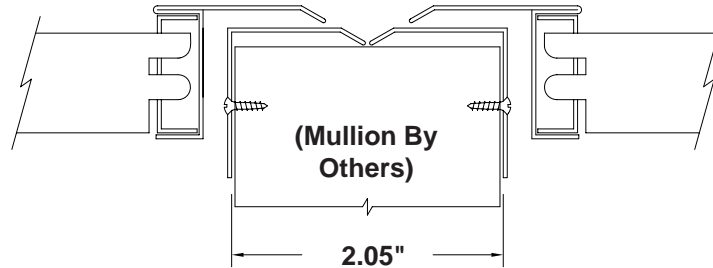

SINGLE DEFLECTION *

60" < Listed Size ≤ 120"

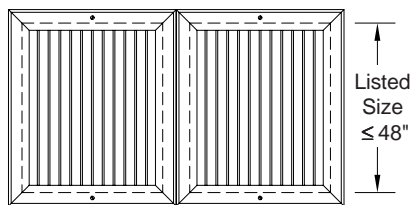

OR

SINGLE DEFLECTION *

48" < Listed Size ≤ 96"

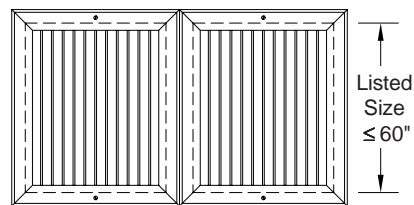

OR

60" < Listed Size ≤ 120"

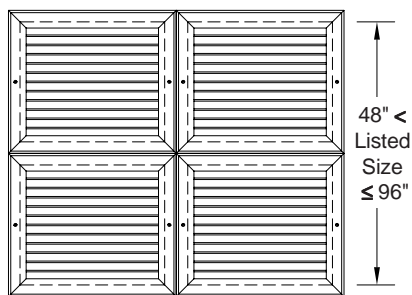

48" < Listed Size ≤ 96"

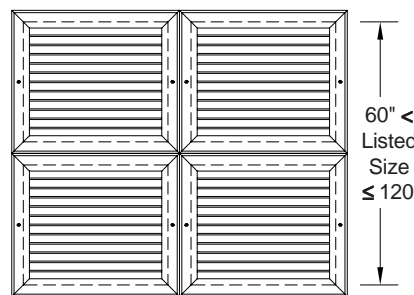

* Blades can be either vertical or horizontal for the dimensions shown.

To maintain KEES' policy of continuous product improvement, we reserve the right to change prices, specifications, ratings or dimensions without notice or obligation.

Project			Location			
Engineer			 KEES INCORPORATED 400 S. Industrial Dr. • P.O. Box L Elkhart Lake, WI 53020 Phone: (920) 876-3391 Fax: (920) 876-3065 Website: www.kees.com			
Architect		Dwg. No.				SD-SSFG
Contractor		Date				05/07