

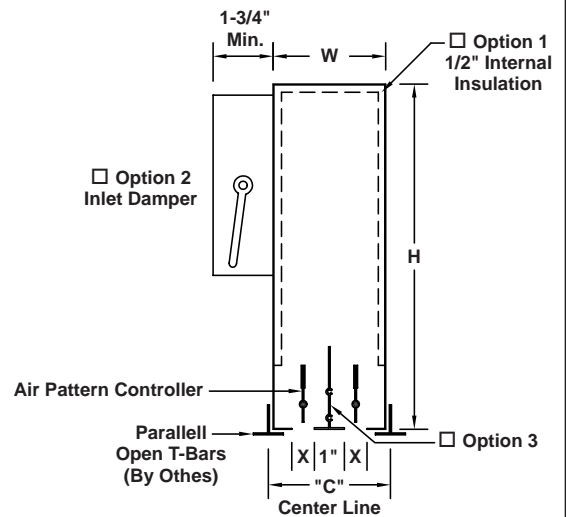

# MODEL "K" DIFFUSER WITH ADJUSTABLE BLADE 2-Slot Model

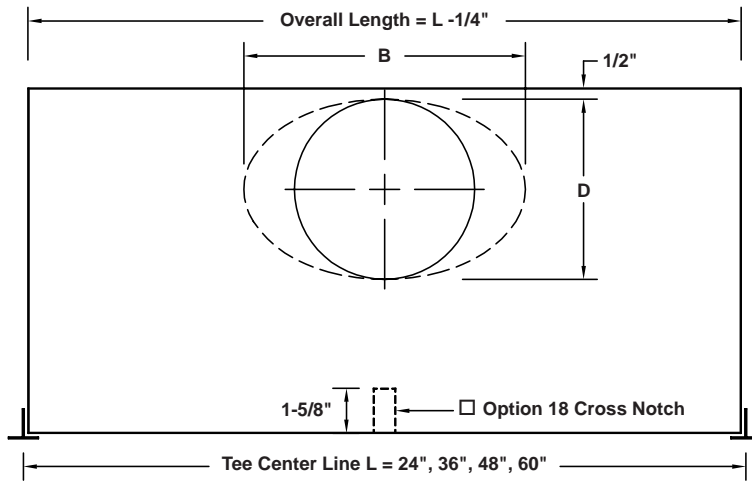

## ACCESSORY OPTIONS

NOMINAL INLET SIZE	B	D	H
6" RD.	5-7/8"	5-7/8"	11-5/8"
8" RD.	7-7/8"	7-7/8"	
10" OV.	11-1/2"	8"	
12" OV.	14-1/2"	8"	
10" RD.	9-7/8"	9-7/8"	13-5/8"
12" RD.	11-7/8"	11-7/8"	15-5/8"

MODEL	SLOT WIDTH X	W	C
K-50-2	1/2"	3-1/8"	3-3/8"
K-75-2	3/4"	3-5/8"	3-7/8"
K-100-2	1"	4-1/8"	4-3/8"
K-150-2	1-1/2"	5-1/8"	5-3/8"

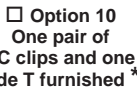
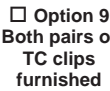
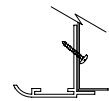
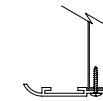
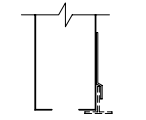
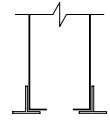
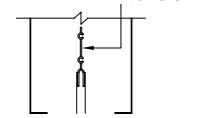
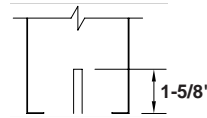
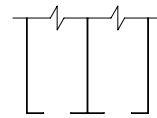

**Material:** 24 gauge zinc coated steel. Pattern controller extruded aluminum with felt wiper seal.

**Finish:** Diffuser face and pattern controller flat black, tees are white.

Inlet Collar Location: Inlet collar may be offset for packaging purposes.

\* Specify inlet side or side opposite inlet if ordering Options 5, 8, or 10.

Quantity	Model	Length L	Height H	Inlet Size	Options	Tag

To maintain KEES' policy of continuous product improvement, we reserve the right to change prices, specifications, ratings or dimensions without notice or obligation.

<b>Project</b>		<b>Location</b>		 <b>KEES INCORPORATED</b> 400 S. Industrial Dr. • P.O. Box L Elkhart Lake, WI 53020 Phone: (920) 876-3391 Fax: (920) 876-3065 Website: www.kees.com
<b>Engineer</b>		<b>Dwg. No.</b>	<b>Diff.-KS-2</b>	
<b>Architect</b>		<b>Date</b>	<b>12/09</b>	
<b>Contractor</b>				

# MODEL "KLP - LOW PROFILE" DIFFUSER WITH ADJUSTABLE BLADE

## 1-Slot Model

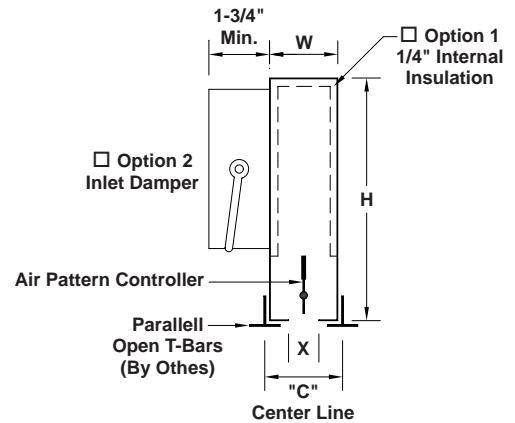
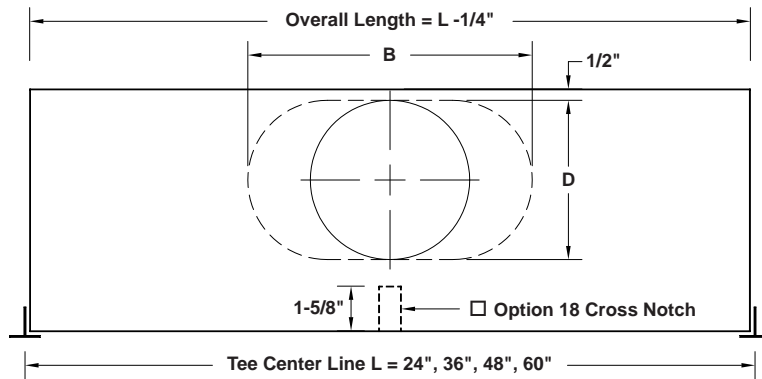

NOMINAL INLET SIZE	B	D	H
6" SLOT	6-1/4"	5-1/4"	8"
8" SLOT	9-3/8"	5-1/4"	
10" SLOT	12-1/2"	5-1/4"	
12" SLOT	15-5/8"	5-3/4"	

MODEL	SLOT WIDTH X	W	C
KLP-50-1	1/2"	1-5/8"	1-7/8"
KLP-75-1	3/4"	1-7/8"	2-1/8"
KLP-100-1	1"	2-1/8"	2-3/8"
KLP-150-1	1-1/2"	2-5/8"	2-7/8"

### ACCESSORY OPTIONS

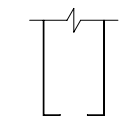

Standard  
No side T's or clips furnished

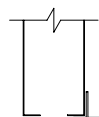

Option 5  
One side T furnished \*

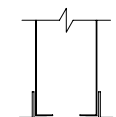

Option 7  
Both side T's furnished

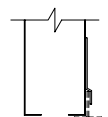

Option 8  
One pair of TC clips furnished \*

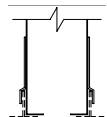

Option 9  
Both pairs of TC clips furnished

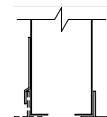

Option 10  
One pair of TC clips and one side T furnished \*

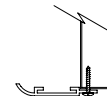

Option 11  
Frame screwed onto plenum lip using pan head screws. Off-white finish. Shipped loose.

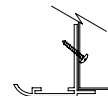

Option 12  
Frame for concealed fastening. Off-white finish. Shipped loose. Field Drilled.

**Material:** 24 gauge zinc coated steel. Pattern controller extruded aluminum with felt wiper seal.

**Finish:** Diffuser face and pattern controller flat black.

Inlet Collar Location: Inlet collar may be offset for packaging purposes.

\* Specify inlet side or side opposite inlet if ordering Options 5, 8, or 10.

Quantity	Model	Length L	Height H	Inlet Size	Options	Tag

To maintain KEES' policy of continuous product improvement, we reserve the right to change prices, specifications, ratings or dimensions without notice or obligation.

<b>Project</b>		<b>Location</b>		 <b>KEES INCORPORATED</b> 400 S. Industrial Dr. • P.O. Box L Elkhart Lake, WI 53020 Phone: (920) 876-3391 Fax: (920) 876-3065 Website: www.kees.com
<b>Engineer</b>		<b>Dwg. No.</b>	<b>Diff.-KLP-1</b>	
<b>Architect</b>		<b>Date</b>	<b>12/09</b>	
<b>Contractor</b>				

# MODEL "KLP - LOW PROFILE" DIFFUSER WITH ADJUSTABLE BLADE

## 2-Slot Model

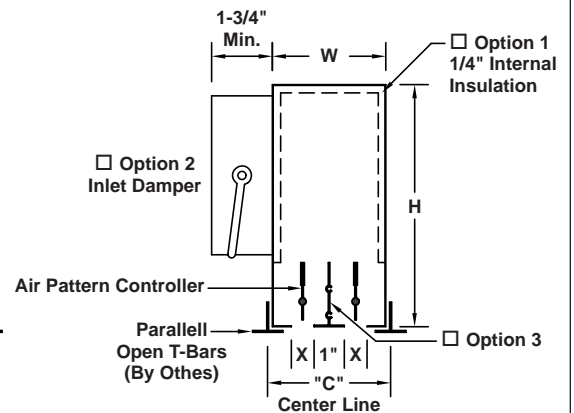
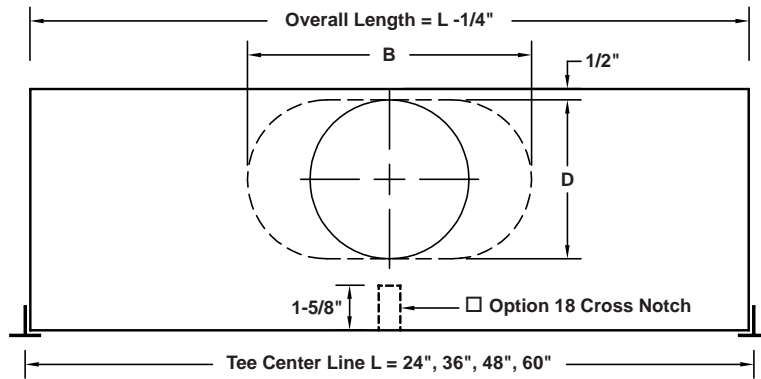

NOMINAL INLET SIZE	B	D	H
6" SLOT	6-1/4"	5-1/4"	8"
8" SLOT	9-3/8"	5-1/4"	
10" SLOT	12-1/2"	5-1/4"	
12" SLOT	15-5/8"	5-3/4"	

MODEL	SLOT WIDTH X	W	C
KLP-50-2	1/2"	3-1/8"	3-3/8"
KLP-75-2	3/4"	3-5/8"	3-7/8"
KLP-100-2	1"	4-1/8"	4-3/8"
KLP-150-2	1-1/2"	5-1/8"	5-3/8"

### ACCESSORY OPTIONS

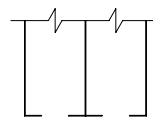

Option 3  
Factory installed  
Center T

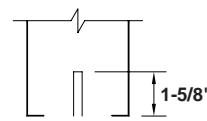

Option 4  
Slot provided in ends  
to fit astride ceiling  
grid T-bar (by others)

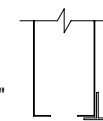

Option 5  
One side T  
furnished \*

Center T  
Extension

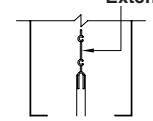

Option 6  
2-slot one-way blow only -  
T-extension is added to  
fit over existing grid  
T-bar (by others)  
Slot provided in ends

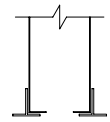

Option 7  
Both side T's  
furnished



Option 8  
One pair of  
TC clips furnished \*

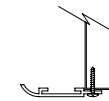

Option 11  
Frame  
screwed onto  
plenum lip using  
pan head screws.  
Off-white finish.  
Shipped loose.

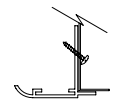

Option 12  
Frame for con-  
cealed fastening.  
Off-white finish.  
Shipped loose.  
Field Drilled.

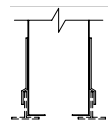

Option 9  
Both pairs of  
TC clips  
furnished

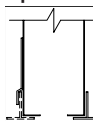

Option 10  
One pair of  
TC clips and one  
side T furnished \*

**Material:** 24 gauge zinc coated steel. Pattern controller extruded aluminum with felt wiper seal.

**Finish:** Diffuser face and pattern controller flat black, tees are white.

Inlet Collar Location: Inlet collar may be offset for packaging purposes.

\* Specify inlet side or side opposite inlet if ordering Options 5, 8, or 10.

Quantity	Model	Length L	Height H	Inlet Size	Options	Tag

To maintain KEES' policy of continuous product improvement, we reserve the right to change prices, specifications, ratings or dimensions without notice or obligation.

<b>Project</b>				<b>Location</b>		
<b>Engineer</b>						
<b>Architect</b>			<b>Dwg. No.</b>	<b>Diff.-KLP-2</b>		
<b>Contractor</b>			<b>Date</b>	<b>12/09</b>		



**KEES INCORPORATED**  
 400 S. Industrial Dr. • P.O. Box L  
 Elkhart Lake, WI 53020  
 Phone: (920) 876-3391  
 Fax: (920) 876-3065  
 Website: www.kees.com



# MODEL "K" DIFFUSER WITH ADJUSTABLE BLADE 4-Slot Model

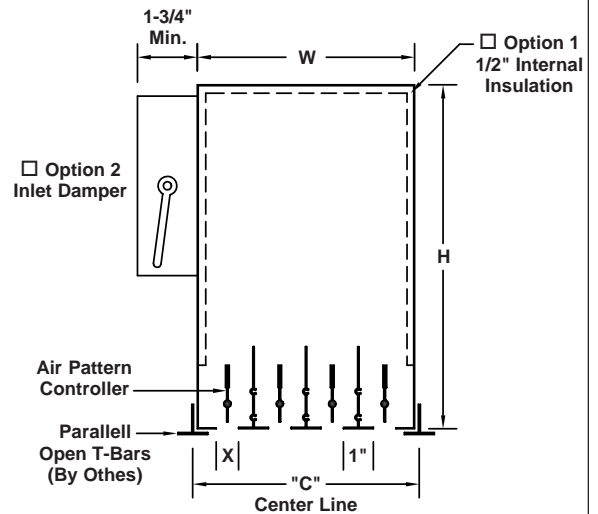
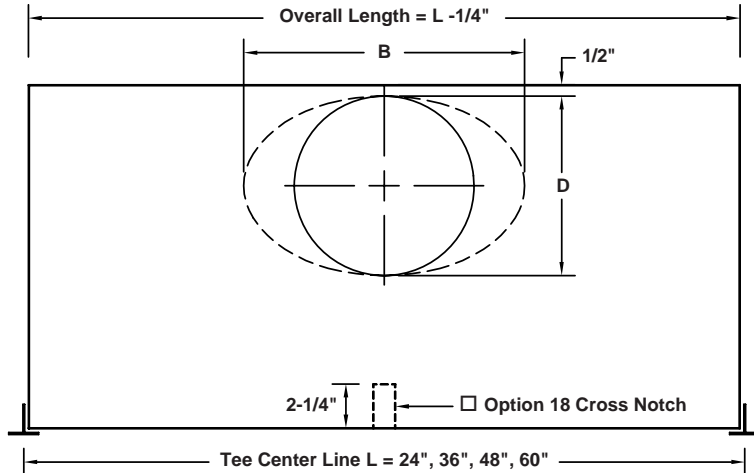

## ACCESSORY OPTIONS

NOMINAL INLET SIZE	B	D	H
8" RD.	7-7/8"	7-7/8"	11-5/8"
10" OVAL	11-1/2"	8"	
10" RD.	9-7/8"	9-7/8"	13-5/8"
12" OVAL	13-7/8"	9-9/16"	
14" SLOT	16-1/8"	9-7/8"	

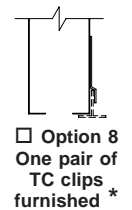
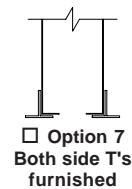
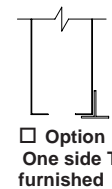
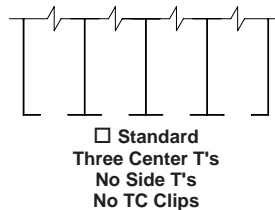

MODEL	SLOT WIDTH X	W	C
K-50-4	1/2"	6-1/8"	6-3/8"
K-75-4	3/4"	7-1/8"	7-3/8"
K-100-4	1"	8-1/8"	8-3/8"
K-150-4	1-1/2"	10-1/8"	10-3/8"

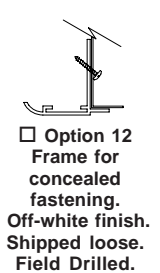
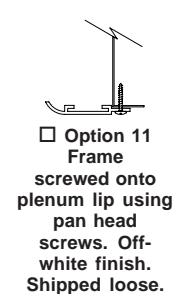
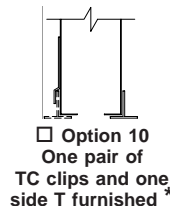
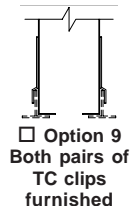

**Material:** 24 gauge zinc coated steel. Pattern controller extruded aluminum with felt wiper seal.

**Finish:** Diffuser face and pattern controller flat black, tees are white.

**Inlet Collar Location:** Inlet collar may be offset for packaging purposes.

\* *Specify inlet side or side opposite inlet if ordering Options 5, 8, or 10.*

Quantity	Model	Length L	Height H	Inlet Size	Options	Tag

To maintain KEES' policy of continuous product improvement, we reserve the right to change prices, specifications, ratings or dimensions without notice or obligation.

<b>Project</b>				<b>Location</b>			
<b>Engineer</b>				 <b>KEES INCORPORATED</b> 400 S. Industrial Dr. • P.O. Box L Elkhart Lake, WI 53020 Phone: (920) 876-3391 Fax: (920) 876-3065 Website: www.kees.com			
<b>Architect</b>			<b>Dwg. No.</b>				<b>Diff.-KS-4</b>
<b>Contractor</b>			<b>Date</b>				<b>05/07</b>

# MODEL "K" DIFFUSER WITH ADJUSTABLE BLADE 6 & 8 -Slot Models

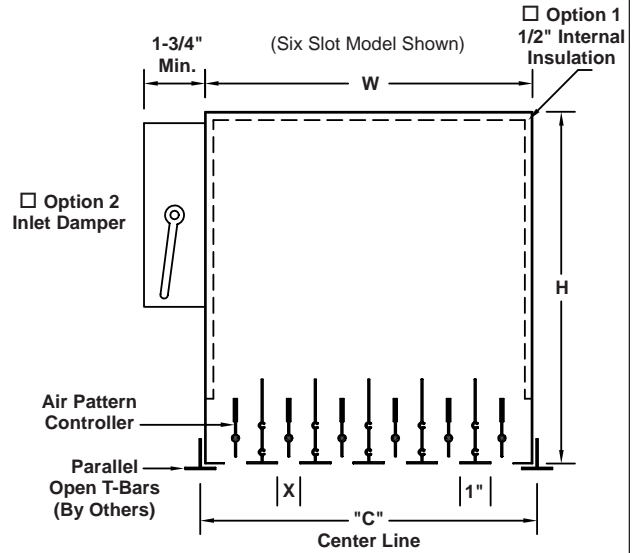
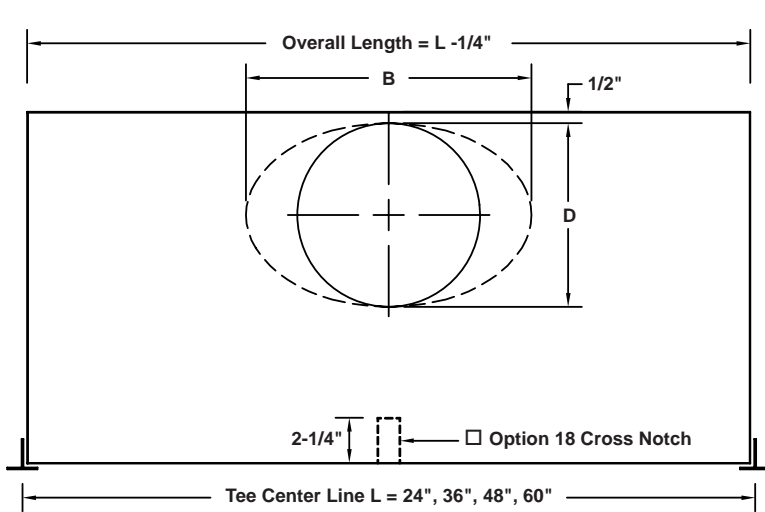

NOMINAL INLET SIZE	B	D	H
8" RD.	7-7/8"	7-7/8"	11-5/8"
10" OVAL	11-1/2"	8"	13-5/8"
12" OVAL	13-7/8"	9-9/16"	
14" SLOT	16-1/8"	9-7/8"	
16" SLOT	19-5/16"	9-7/8"	
18" SLOT	22-7/16"	9-7/8"	

	MODEL	SLOT WIDTH X	W	C
6 S L O T S	K-50-6	1/2"	9-1/8"	9-3/8"
	K-75-6	3/4"	10-5/8"	10-7/8"
	K-100-6	1"	12-1/8"	12-3/8"
	K-150-6	1-1/2"	15-1/8"	15-3/8"
8 S L O T S	K-50-8	1/2"	12-1/8"	12-3/8"
	K-75-8	3/4"	14-1/8"	14-3/8"
	K-100-8	1"	16-1/8"	16-3/8"
	K-150-8	1-1/2"	20-1/8"	20-3/8"

## ACCESSORY OPTIONS

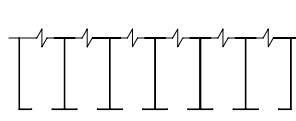

Standard Five or Seven Center T's No Side T's No TC Clips

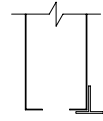

Option 5 One side T furnished \*

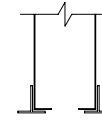

Option 7 Both side T's furnished

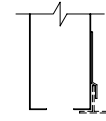

Option 8 One pair of TC clips furnished \*

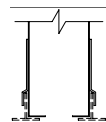

Option 9 Both pairs of TC clips furnished

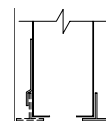

Option 10 One pair of TC clips and one side T furnished \*

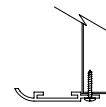

Option 11 Frame screwed onto plenum lip using pan head screws. Off-white finish. Shipped loose.

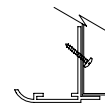

Option 12 Frame for concealed fastening. Off-white finish. Shipped loose. Field Drilled.

**Material:** 24 gauge zinc coated steel. Pattern controller extruded aluminum with felt wiper seal.

**Finish:** Diffuser face and pattern controller flat black, tees are white.

Inlet Collar Location: Inlet collar may be offset for packaging purposes.

\* Specify inlet side or side opposite inlet if ordering Options 5, 8, or 10.

Quantity	Model	Length L	Height H	Inlet Size	Options	Tag

To maintain KEES' policy of continuous product improvement, we reserve the right to change prices, specifications, ratings or dimensions without notice or obligation.

<b>Project</b>		<b>Location</b>	
<b>Engineer</b>		<b>Diff.- KS-6 &amp; 8</b>	
<b>Architect</b>		<b>Dwg. No.</b>	<b>Date</b>
<b>Contractor</b>		<b>Date</b>	<b>05/07</b>



**KEES INCORPORATED**  
 400 S. Industrial Dr. • P.O. Box L  
 Elkhart Lake, WI 53020  
 Phone: (920) 876-3391  
 Fax: (920) 876-3065  
 Website: www.kees.com



# OPTIONS FOR "K" AND "KLP" AIR DIFFUSERS FOR USE WITH 15/16" TEE BAR GRID

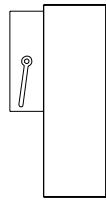

**Option 1**  
Internal Insulation

**Option 2**  
Inlet Damper With Manual Quadrant

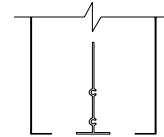

**Option 3**  
Factory Installed Extruded Center T. On 2 Slot Unit

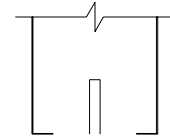

**Option 4**  
Slot Provided In Ends To Fit Astride Ceiling Grid T-Bar (By Others). On 2 Slot Unit

Center "T" Extension

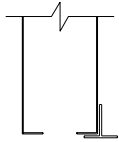

**Option 5**  
One Side T Furnished

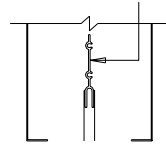

**Option 6**  
2 Slot One-Way Blow Only - T-Extension Is Added To Fit Over Existing Grid T-Bar (By Others). Slot Provided In Ends

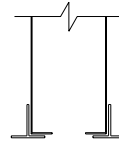

**Option 7**  
Both Side T's Furnished

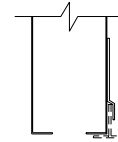

**Option 8**  
One Pair Of TC Clips Furnished

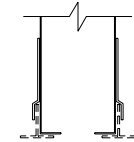

**Option 9**  
Both Pairs Of TC Clips Furnished

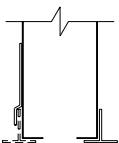

**Option 10**  
One Pair Of TC Clips And One Side T Furnished



**Option 11**  
Flat Extruded Aluminum Frame Screwed Into Plenum Lip Using Pan Head Screws On 12" Centers. Off-white Finish.

## FRAMES FOR HARD CEILINGS



**Option 12**  
Extruded Aluminum Frame. No Surface Screws. Fastened Thru Slot Opening. Off-white Finish.



**Option 13**  
Continuous Run Of Active And Inactive Sections For Hard Ceiling. Center "T"s Look Continuous With Options 11 Or 12 Separate Frame Around Perimeter.

## Options 14 and 15

Configurations For Use With Donn Finline, Chicago Metallic, Armstrong (And Others) Ceilings With 9/16" Wide Tees. "K" Diffuser Only. See Separate Documentation For 9/16" Tee Option Nomenclature.

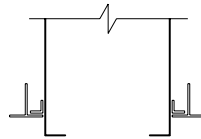

**Option 16**  
Tegular Ceiling "K" Diffusers Only

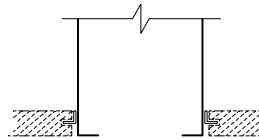

**Option 17**  
Splined Ceiling "K" Diffusers Only

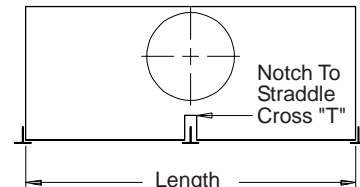

**Option 18**  
Cross Notch For Cross "T"

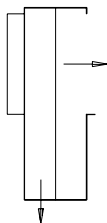

**Option 19**  
Combination Supply-Return Unit. Return Collar Available.



**Option 20**  
Top Inlet. "K" Diffusers Only.

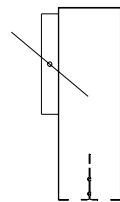

**Option 21**  
Face Operated Damper Using Wire Hook.

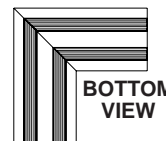

**Option 22**  
90 Deg. Angles - Inactive Units Only.

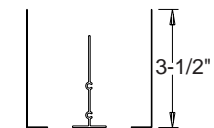

**Option 23**  
No Plenum - Top Open Or Closed. "K" Diffusers Only.

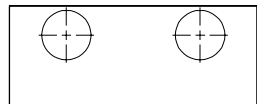

**Option 24**  
Multiple Collars In Diffuser

**Option 25**  
Individually Packaged Units

**Option 26**  
Individually Tagged Units

**Option 27**  
Non-Standard Inlet Collars And Dampers

HIGHER

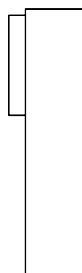

LOWER

**Option 28**  
Non-Standard Unit Height. "K" Diffusers Only.

**Option 29**  
Internal Or External Foil Faced Insulation

**Option 30**  
All Stainless Steel Construction

**Option 31**  
All Aluminum Construction

<b>Project</b>			<b>Location</b>			
<b>Engineer</b>			 <b>KEES INCORPORATED</b> 400 S. Industrial Dr. • P.O. Box L Elkhart Lake, WI 53020 Phone: (920) 876-3391 Fax: (920) 876-3065 Website: www.kees.com			
<b>Architect</b>		<b>Dwg. No.</b>				<b>OPTIONS</b>
<b>Contractor</b>		<b>Date</b>				<b>12-01</b>



# MODEL "K" RETURN AIR 2-Slot Model

## DUCTED

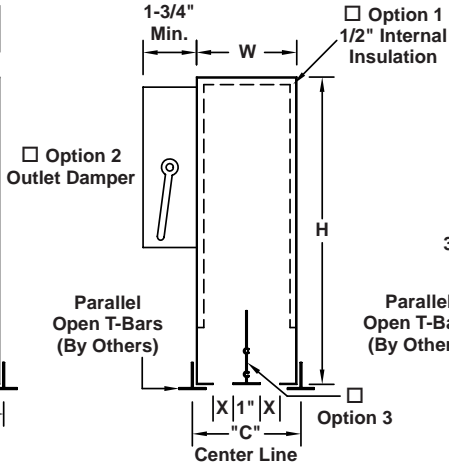
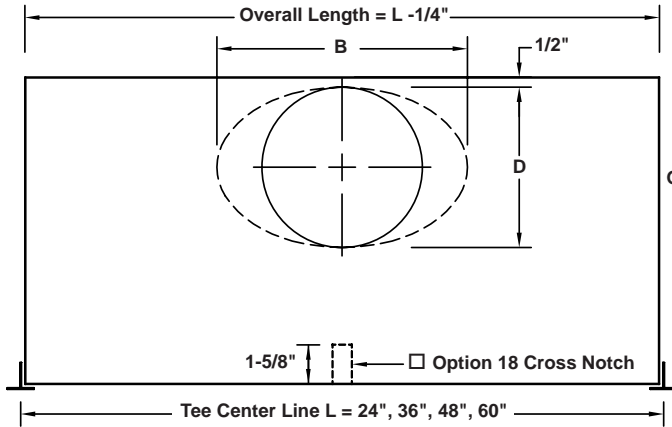

## PLENUM RETURN

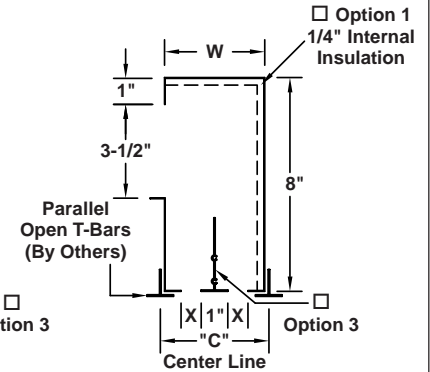

## ACCESSORY OPTIONS

NOMINAL OUTLET SIZE	B	D	H
6" RD.	5-7/8"	5-7/8"	11-5/8"
8" RD.	7-7/8"	7-7/8"	
10" OVAL	11-1/2"	8"	
PLENUM RETURN	-	-	8"

MODEL	SLOT WIDTH X	W	C
KR-50-2	1/2"	3-1/8"	3-3/8"
KR-75-2	3/4"	3-5/8"	3-7/8"
KR-100-2	1"	4-1/8"	4-3/8"
KR-150-2	1-1/2"	5-1/8"	5-3/8"

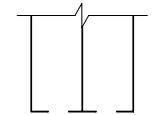

Option 3  
Factory installed Center T

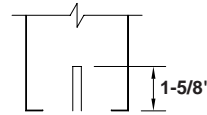

Option 4  
Slot provided in ends to fit astride ceiling grid T-bar (by others)



Option 5  
One side T furnished \*

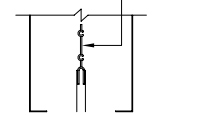

Option 6  
2-slot one-way blow only - T-extension is added to fit over existing grid T-bar (by others). Slot provided in ends

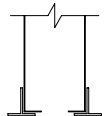

Option 7  
Both side T's furnished

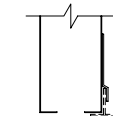

Option 8  
One pair of TC clips furnished \*

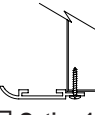

Option 11  
Frame screwed onto plenum lip using pan head screws. Off-white finish. Shipped loose.

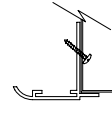

Option 12  
Frame for concealed fastening. Off-white finish. Shipped loose. Field Drilled.

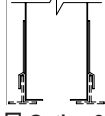

Option 9  
Both pairs of TC clips furnished

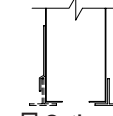

Option 10  
One pair of TC clips and one side T furnished \*

**Material:** 24 gauge zinc coated steel.  
**Finish:** Diffuser face flat black, tees are white.

Outlet Collar Location: Outlet collar may be offset for packaging purposes.  
\* Specify outlet side or side opposite outlet if ordering Options 5, 8, or 10.

Quantity	Model	Length L	Height H	Outlet Size	Options	Tag

To maintain KEES' policy of continuous product improvement, we reserve the right to change prices, specifications, ratings or dimensions without notice or obligation.

<b>Project</b>			<b>Location</b>			
<b>Engineer</b>				 <b>KEES INCORPORATED</b> 400 S. Industrial Dr. • P.O. Box L Elkhart Lake, WI 53020 Phone: (920) 876-3391 Fax: (920) 876-3065 Website: www.kees.com		
<b>Architect</b>		<b>Dwg. No.</b>	<b>Diff.-KR-2</b>			
<b>Contractor</b>		<b>Date</b>	<b>05/07</b>			

# MODEL "K" RETURN AIR 3-Slot Model

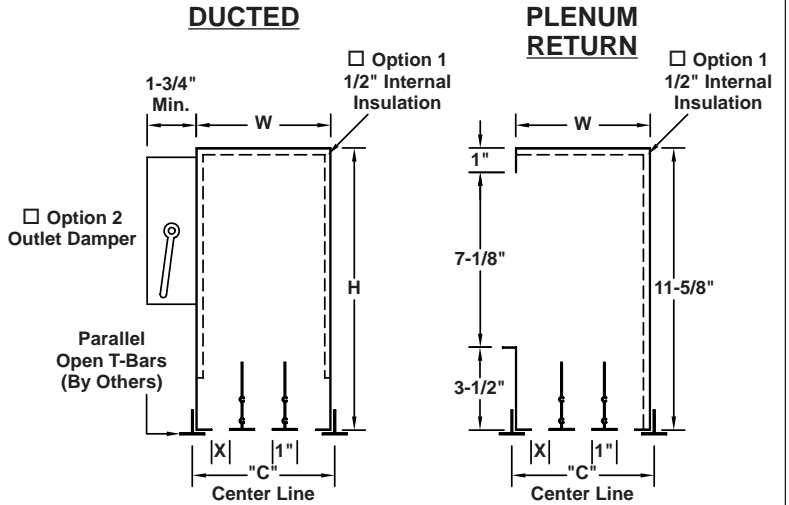
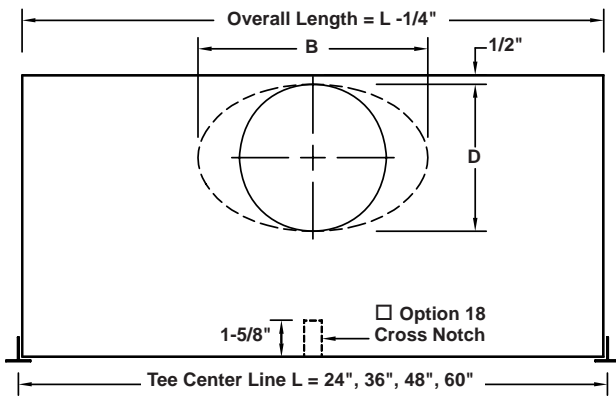

## ACCESSORY OPTIONS

NOMINAL OUTLET SIZE	B	D	H
6" RD.	5-7/8"	5-7/8"	11-5/8"
8" RD.	7-7/8"	7-7/8"	
10" OVAL	11-1/2"	8"	13-5/8"
10" RD.	9-7/8"	9-7/8"	
12" OVAL	13-7/8"	9-9/16"	
PLENUM RETURN	-	-	11-5/8"

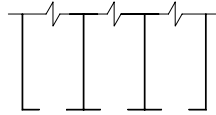

Standard  
Two Center T's  
No Side T's  
No TC Clips

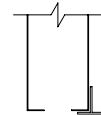

Option 5  
One side T  
furnished \*

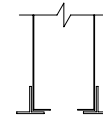

Option 7  
Both side T's  
furnished

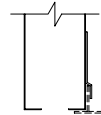

Option 8  
One pair of  
TC clips  
furnished \*

MODEL	SLOT WIDTH X	W	C
KR-50-3	1/2"	4-5/8"	4-7/8"
KR-75-3	3/4"	5-3/8"	5-5/8"
KR-100-3	1"	6-1/8"	6-3/8"
KR-150-3	1-1/2"	7-5/8"	7-7/8"

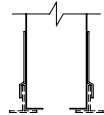

Option 9  
Both pairs of  
TC clips  
furnished

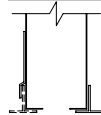

Option 10  
One pair of  
TC clips and  
one side T  
furnished \*

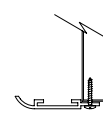

Option 11  
Frame  
screwed onto  
plenum lip using  
pan head screws.  
Off-white finish.  
Shipped loose.

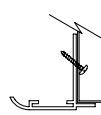

Option 12  
Frame for  
concealed  
fastening.  
Off-white finish.  
Shipped loose.  
Field Drilled.

**Material:** 24 gauge zinc coated steel.  
**Finish:** Diffuser face flat black, tees are white.

Outlet Collar Location: Outlet collar may be offset for packaging purposes.  
\* Specify outlet side or side opposite outlet if ordering Options 5, 8, or 10.

Quantity	Model	Length L	Height H	Outlet Size	Options	Tag

To maintain KEES' policy of continuous product improvement, we reserve the right to change prices, specifications, ratings or dimensions without notice or obligation.

<b>Project</b>				<b>Location</b>		
<b>Engineer</b>						
<b>Architect</b>			<b>Dwg. No.</b>	<b>Diff.-</b> KR-3		
<b>Contractor</b>			<b>Date</b>	<b>05/07</b>		



**KEES INCORPORATED**  
400 S. Industrial Dr. • P.O. Box L  
Elkhart Lake, WI 53020  
Phone: (920) 876-3391  
Fax: (920) 876-3065  
Website: www.kees.com

# MODEL "K" RETURN AIR 4-Slot Model

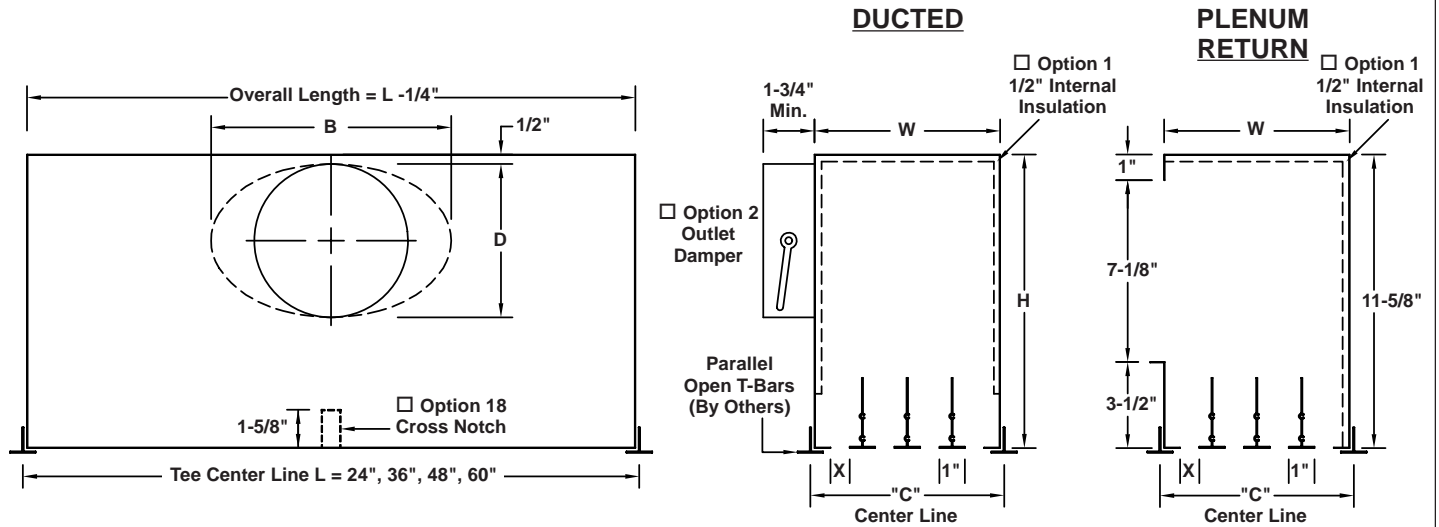

NOMINAL OUTLET SIZE	B	D	H
8" RD.	7-7/8"	7-7/8"	11-5/8"
10" OVAL	11-1/2"	8"	
10" RD.	9-7/8"	9-7/8"	
12" OVAL	13-7/8"	9-9/16"	13-5/8"
14" SLOT	16-1/8"	9-7/8"	11-5/8"
PLENUM RETURN	-	-	11-5/8"

MODEL	SLOT WIDTH X	W	C
KR-50-4	1/2"	6-1/8"	6-3/8"
KR-75-4	3/4"	7-1/8"	7-3/8"
KR-100-4	1"	8-1/8"	8-3/8"
KR-150-4	1-1/2"	10-1/8"	10-3/8"

## ACCESSORY OPTIONS

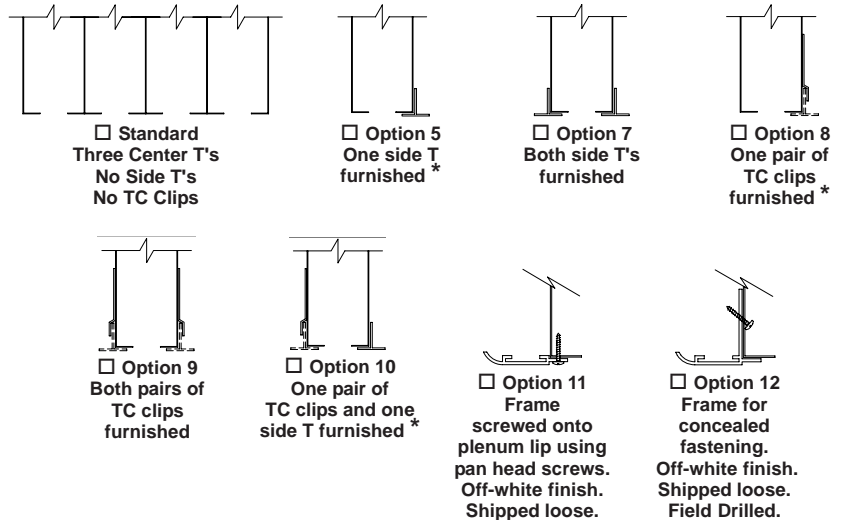

**Material:** 24 gauge zinc coated steel.  
**Finish:** Diffuser face flat black, tees are white.

Outlet Collar Location: Outlet collar may be offset for packaging purposes.  
 \* Specify outlet side or side opposite outlet if ordering Options 5, 8, or 10.

Quantity	Model	Length L	Height H	Outlet Size	Options	Tag

To maintain KEES' policy of continuous product improvement, we reserve the right to change prices, specifications, ratings or dimensions without notice or obligation.

<b>Project</b>				<b>Location</b>		
<b>Engineer</b>				<b>Dwg. No.</b>	<b>Diff.-KR-4</b>	 <b>KEES INCORPORATED</b> 400 S. Industrial Dr. • P.O. Box L Elkhart Lake, WI 53020 Phone: (920) 876-3391 Fax: (920) 876-3065 Website: www.kees.com
<b>Architect</b>						
<b>Contractor</b>				<b>Date</b>	<b>05/07</b>	