

MODEL "F-FL" DIFFUSER WITH FIXED BLADE 1 thru 4 Slot Models FOR USE WITH 9/16" WIDE TEE CEILINGS (OPT. 14)

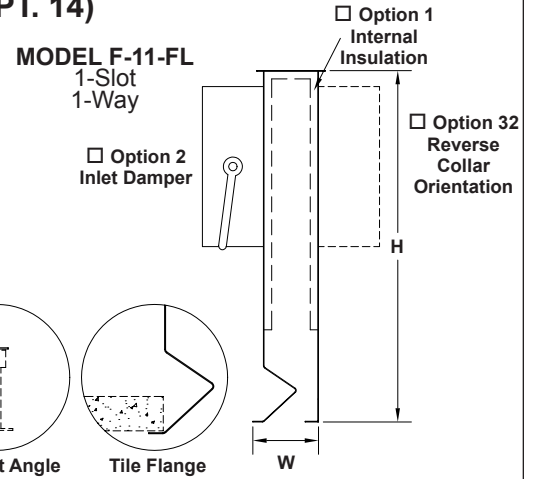

MODEL	DIFFUSER WIDTH W			NOMINAL INLET SIZE	B	D	H
	ONE WAY	OPT. 3	OPT. 4				
F-11-FL	1.975	-	-	6" RD.	5-7/8"	5-7/8"	11-1/4"
F-21-FL	3.631	-	-	8" RD.	7-7/8"	7-7/8"	
F-22-FL	-	4.079	4.641	10" OV.	11-1/2"	8"	
F-31-FL	5.285	-	-	12" SLOT	14-1/2"	8"	13-1/4"
F-32-FL	-	5.734	6.292	10" RD.	9-7/8"	9-7/8"	
F-41-FL	6.940	-	-	12" OV.	13-7/8"	9-9/16"	
F-42-FL	-	7.389	7.947	12" RD.	11-7/8"	11-7/8"	

CEILING GRID TEE STYLE

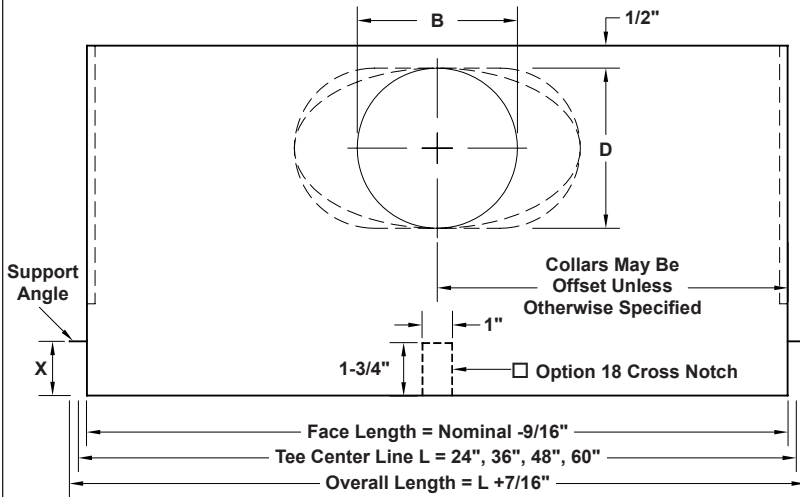
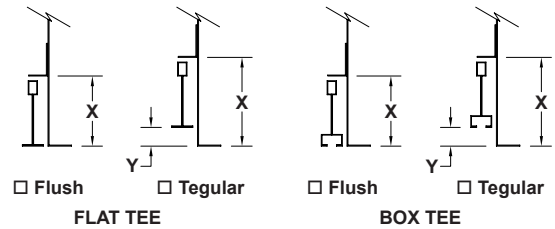

Ceiling Mfg. Name _____
Ceiling Mfg. Model _____

ACCESSORY OPTIONS

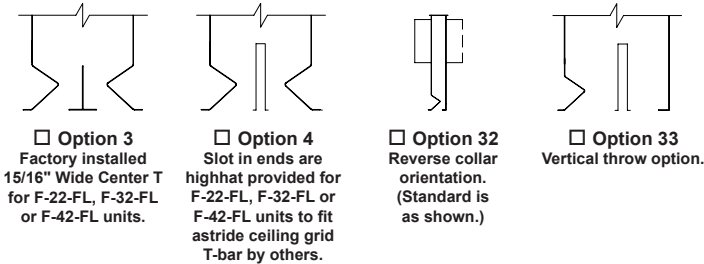

Material: 24 gauge zinc coated steel.
Finish: All white face and interior.
Insulation: 1/4" for 1 slot units and 1/2" for 2 or more slot units.

SUPPLY PATTERNS - 2, 3 & 4 SLOTS F-22-FL, F-32-FL & F-42-FL SHOWN WITH OPTION 4

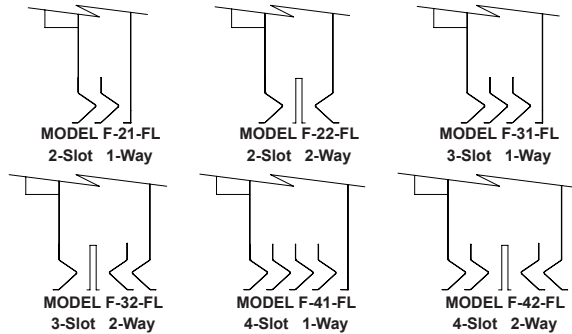

Inlet Collar Location: Inlet collar may be offset for packaging purposes.

Quantity	Model	Length L	Height H	Insulation	Collar Size	Round or Oval Collar	X	Options	Tag

To maintain KEES' policy of continuous product improvement, we reserve the right to change prices, specifications, ratings or dimensions without notice or obligation.

Project		Location	
Engineer		Dwg. No. SD-F-FL	
Architect		Date 05/10	
Contractor			



KEES INCORPORATED
400 S. Industrial Dr. • P.O. Box L
Elkhart Lake, WI 53020
Phone: (920) 876-3391
Fax: (920) 876-3065
Website: www.kees.com

MODEL "FR-FL" DIFFUSER WITH FIXED BLADE OPEN SIDE RETURN

1 thru 4 Slot Models

FOR USE WITH 9/16" WIDE TEE CEILINGS

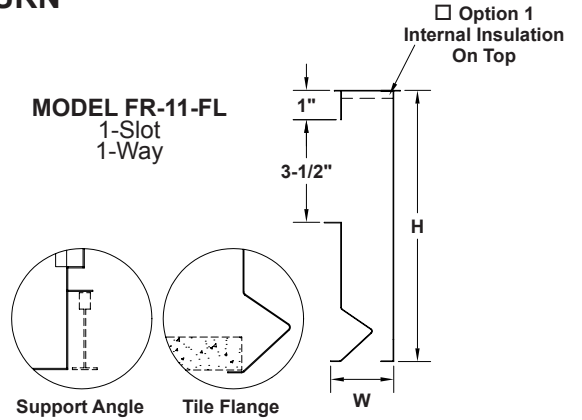
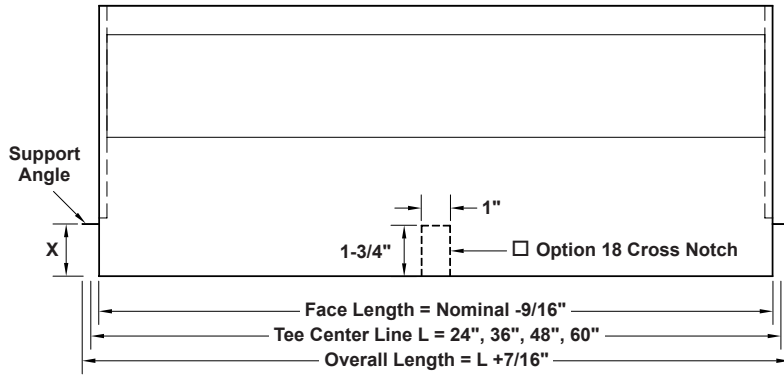

MODEL	DIFFUSER WIDTH W			H
	ONE WAY	OPT. 3	OPT. 4	
FR-11-FL	1.975	-	-	9-1/4"
FR-21-FL	3.631	-	-	
FR-22-FL	-	4.079	4.641	
FR-31-FL	5.285	-	-	
FR-32-FL	-	5.734	6.292	
FR-41-FL	6.940	-	-	
FR-42-FL	-	7.389	7.947	

CEILING GRID TEE STYLE

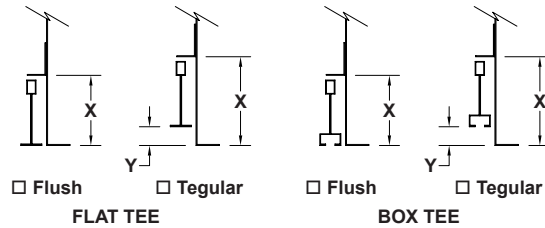

Ceiling Mfg. Name _____
 Ceiling Mfg. Model _____

ACCESSORY OPTIONS

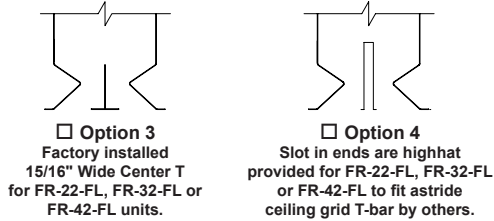

Material: 24 gauge zinc coated steel.
Finish: All white face and interior.
Insulation: 1/4" for 1 slot units and 1/2" for 2 or more slot units.

FOR DUCTED RETURN SEE REVERSE SIDE

NON-DUCTED RETURN PATTERNS - 2, 3 & 4 SLOTS

FR-22-FL, FR-32-FL & FR-42-FL SHOWN WITH OPTION 4

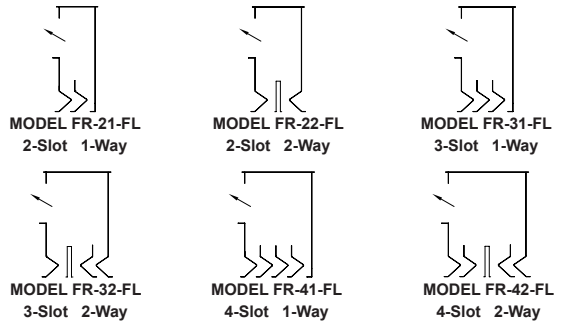

Quantity	Model	Length L	Insulation	X	Options	Tag

To maintain KEES' policy of continuous product improvement, we reserve the right to change prices, specifications, ratings or dimensions without notice or obligation.

Project				Location		
Engineer				Dwg. No.	SD-FR-FL	KEES INCORPORATED 400 S. Industrial Dr. • P.O. Box L Elkhart Lake, WI 53020 Phone: (920) 876-3391 Fax: (920) 876-3065 Website: www.kees.com
Architect						
Contractor						