

STRAIGHT RAIL EQUIPMENT SUPPORTS

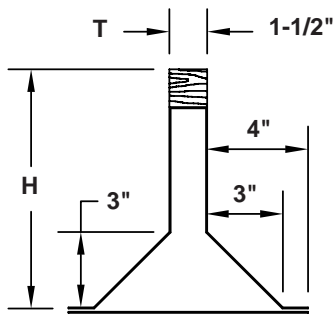

MODEL 15

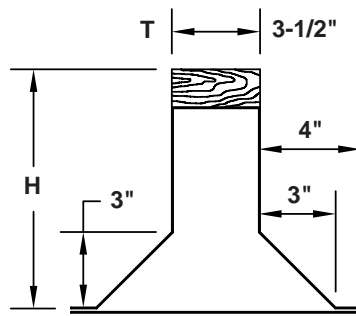

MODEL 35

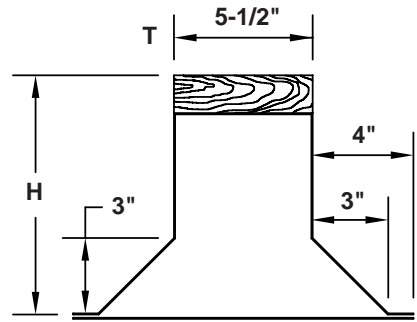

MODEL 55

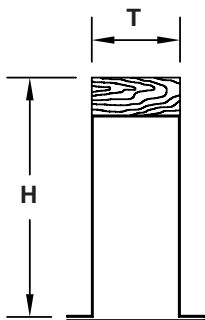

MODEL SF
Self-Flashing
Models Available
In 1-1/2", 3-1/2" & 5-1/2"

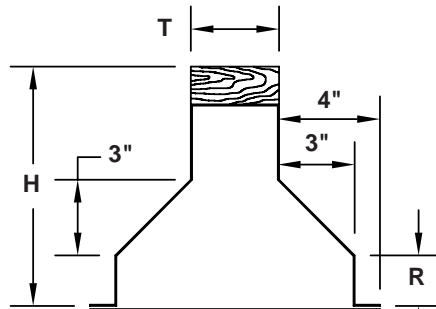

MODEL RC
Raised Cant Available
In All Styles

NOTE: Specify "R"
Measurement

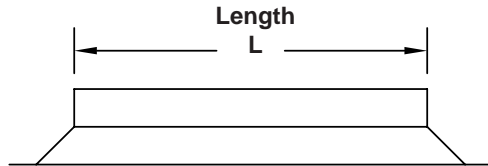
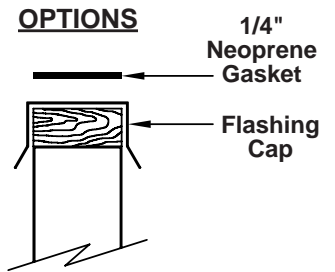

Material: 18 GA. Galvanized (Standard)
.063" Aluminum (Available Option)

Qty.	Model	T	H	L	R	Wood Nailer	Flashing Cap	Neoprene Gasket	Gauge Galv.	Tag

SPECIAL:

To maintain KEES' policy of continuous product development, we reserve the right to change prices, specifications, ratings and dimensions without notice or obligation.

Project				Location		
Engineer				Dwg. No.	SD-RES	 KEES INCORPORATED 400 S. Industrial Dr. Elkhart Lake, WI 53020 Phone: (920) 876-3391 Fax: (920) 876-3065 Website: www.kees.com
Architect				Date	12/07	
Contractor						